

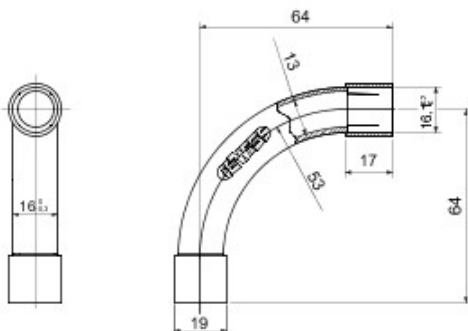

Routing components for rigid protective conduits with IP40 and IP67 protection degree.

Cor	Cinza RAL 7035	Grau de protecção	IP40
Tubos Ø (mm)	16	Tipo de material	Livre halogéneos segundo EN 60754-2
Código Electrocod	21221		

### DIMENSIONAL



### TECHNICAL SYMBOLOGY



### STANDARDS/APPROVALS

